



OWNER'S MANUAL  
MANUAL DE INSTRUCCIONES

**Memorex®**

## 25" MTS STEREO COLOR TELEVISION 25" TELEVISOR COLOR ESTEREO MTS

### MT2252 MT2252 SERIES A

ENGLISH

ESPAÑOL

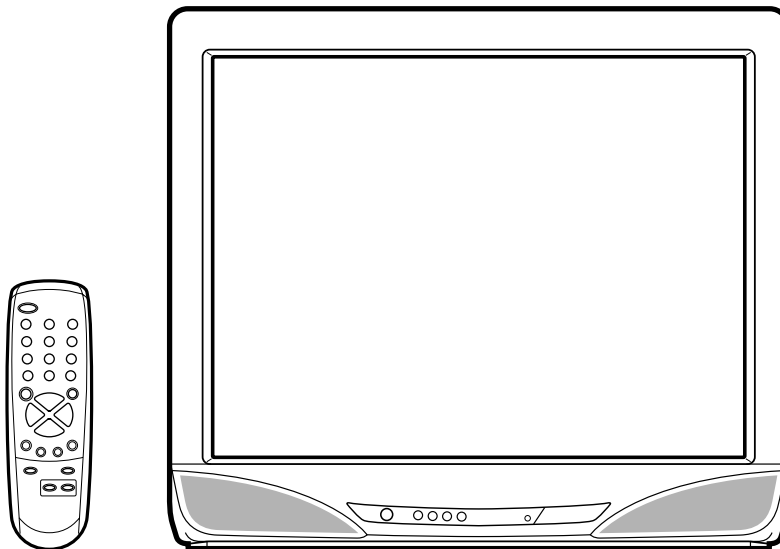

#### ATTENTION

If you purchase a universal remote control from your local retailer, please contact the remote manufacturer for the required programming code.  
Si usted a comprado un control de remoto universal, por favor comunicace con el fabricante para el codico de programacion requerido.

#### TV/CATV MODE SELECTION SELECCION DE MODO DE TV/CATV

When shipped from the factory, the TV/CATV menu option is set to the "CATV" (Cable Television) mode. If not using CATV, set this menu option to "TV" mode.  
Al salir la unidad de fábrica, la opción de menú de TV/CATV se ajusta al modo de "CATV" (Televisión por cable).  
Si no utiliza CATV, ajuste esta opción de menú al modo de "TV".

Before operating the unit, please read this manual thoroughly.  
Antes de usar la unidad, lea detenidamente este manual de instrucciones.



## ENGLISH

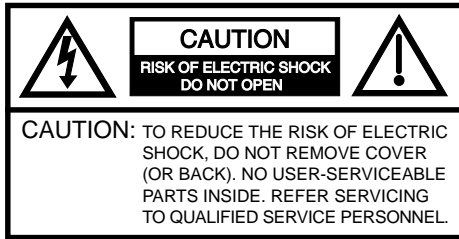

The lightning flash with arrowhead symbol, within an equilateral triangle is intended to alert the user to the presence of uninsulated dangerous voltage within the product's enclosure that may be of sufficient magnitude to constitute a risk of electric shock.



The exclamation point within an equilateral triangle is intended to alert the user to the presence of important operating and maintenance (servicing) instructions in the literature accompanying the appliance.

**CAUTION:** Changes or modifications not expressly approved by the party responsible for compliance with the FCC Rules could void the user's authority to operate this equipment.

**WARNING:** TO PREVENT FIRE OR SHOCK HAZARD, DO NOT EXPOSE THIS APPLIANCE TO RAIN OR MOISTURE.

### NOTE:

Please keep all packaging material for at least 90 days in case you need to return this product to your place of purchase or Memorex.

# IMPORTANT SAFEGUARDS

## 1. READ INSTRUCTIONS

All the safety and operating instructions should be read before the unit is operated.

## 2. RETAIN INSTRUCTIONS

The safety and operating instructions should be retained for future reference.

## 3. HEED WARNINGS

All warnings on the unit and in the operating instructions should be adhered to.

## 4. FOLLOW INSTRUCTIONS

All operating and use instructions should be followed.

## 5. CLEANING

Unplug this unit from the wall outlet before cleaning. Do not use liquid cleaners or aerosol cleaners. Use a damp cloth for cleaning the exterior cabinet only.

## 6. ATTACHMENTS

The manufacturer of this unit does not make any recommendations for attachments, as they may cause hazards.

## 7. WATER AND MOISTURE

Do not use this unit near water. For example, near a bathtub, washbowl, kitchen sink, laundry tub, in a wet basement, or near a swimming pool.

## 8. ACCESSORIES

Do not place this unit on an unstable cart, stand, tripod, bracket, or table.

The unit may fall, causing serious injury, and serious damage to the unit.

- 8A.** An appliance and cart combination should be moved with care. Quick stops, excessive force, and uneven surfaces may cause the appliance and cart combination to overturn.

## 9. VENTILATION

Slots and openings in the cabinet back or bottom are provided for ventilation, to ensure reliable operation of the unit and to protect it from overheating. These openings must not be blocked or covered. The openings should never be blocked by placing the unit on a bed, sofa, rug, or other similar surface. This unit should never be placed near or over a radiator or heat source.

This unit should not be placed in a built-in installation, such as a bookcase, or rack unless proper ventilation is provided or the manufacturer's instructions have been adhered to.

## 10. POWER SOURCE

This unit should be operated only from the type of power source indicated on the rating plate. If you are not sure of the type of power supply to your home, consult your appliance dealer or local power company. For units intended to operate from battery power, or other sources, refer to the operating instructions.

## 11. GROUNDING OR POLARIZATION

This unit is equipped with a polarized alternating current line plug (a plug having one blade wider than the other). This plug will fit into the power outlet only one way. This is a safety feature. If you are unable to insert the plug fully into the outlet, try reversing the plug. If the plug should still fail to fit, contact your electrician to replace your obsolete outlet. Do not defeat the safety purpose of the polarized plug. If your unit is equipped with a 3-wire grounding-type plug, a plug having a third (grounding) pin, this plug will only fit into a grounding-type power outlet. This too, is a safety feature. If you are unable to insert the plug into the outlet, contact your electrician to replace your obsolete outlet. Do not defeat the safety purpose of the grounding-type plug.

## 12. POWERCORD PROTECTION

Power-supply cords should be routed so that they are not likely to be walked on or pinched by items placed upon or against them, paying particular attention to cords at plugs, convenience receptacles, and the point where they exit from the appliance.

PORTABLE CART WARNING  
(symbol provided by RETAC)



S3126A





**13. LIGHTNING**

To protect your unit during a lightning storm, or when it is left unattended and unused for long periods of time, unplug it from the wall outlet and disconnect the antenna or cable system. This will prevent damage to the unit due to lightning and power line surges.

**14. POWER LINES**

An outside antenna system should not be located in the vicinity of overhead power lines, other electric light or power circuits, or where it can fall into such power lines or circuits. When installing an outside antenna system, extreme care should be taken to keep from touching such power lines or circuits as contact with them might be fatal.

**15. OVERLOADING**

Do not overload wall outlets and extension cords as this can result in a risk of fire or electric shock.

**16. OBJECT AND LIQUID ENTRY**

Do not push objects through any openings in this unit as they may touch dangerous voltage points or short out parts that could result in fire or electric shock. Never spill or spray any type of liquid into the unit.

**17. OUTDOOR ANTENNA GROUNDING**

If an outside antenna or cable system is connected to the unit, be sure the antenna or cable system is grounded to provide some protection against voltage surges and built-up static charges. Section 810 of the National Electrical Code, ANSI/NFPA 70, provides information with respect to proper grounding of the mast and supporting structure, grounding of the lead-in wire to an antenna discharge unit, size of grounding conductors, location of antenna discharge unit, connection to grounding electrodes, and requirements for the grounding electrode.

**18. SERVICING**

Do not attempt to service this unit yourself as opening or removing covers may expose you to dangerous voltage or other hazards. Refer all servicing to qualified service personnel.

**19. DAMAGE REQUIRING SERVICE**

Unplug this unit from the wall outlet and refer servicing to qualified service personnel under the following conditions:

- a. When the power-supply cord or plug is damaged.
- b. If liquid has been spilled, or objects have fallen into the unit.
- c. If the unit has been exposed to rain or water.
- d. If the unit does not operate normally by following the operating instructions. Adjust only those controls that are covered by the operating instructions, as an improper adjustment of other controls may result in damage and will often require extensive work by a qualified technician to restore the unit to its normal operation.
- e. If the unit has been dropped or the cabinet has been damaged.
- f. When the unit exhibits a distinct change in performance, this indicates a need for service.

**20. REPLACEMENT PARTS**

When replacement parts are required, be sure the service technician uses replacement parts specified by the manufacturer or those that have the same characteristics as the original part.

Unauthorized substitutions may result in fire, electric shock or other hazards.

**21. SAFETY CHECK**

Upon completion of any service or repairs to this unit, ask the service technician to perform safety checks to determine that the unit is in proper operating condition.

**22. WALL OR CEILING MOUNTING**

If mounting this unit to a wall or ceiling follow the installation recommended by the manufacturer of a mounting bracket specifically designed for this type of product. Use only a mounting device that can handle the weight and size of your unit. Should your bracket require drilling holes into this unit, this would void the manufacturers warranty.

**23. HEAT**

The product should be situated away from heat sources such as radiators, heat registers, stoves, or other products (including amplifiers) that produce heat.

**24. NOTE TO CATV SYSTEM INSTALLER**

This reminder is provided to call the CATV system installer's attention to Article 820-40 of the NEC that provides guidelines for proper grounding and, in particular, specifies that the cable ground shall be connected to the grounding system of the building, as close to the point of cable entry as practical.

EXAMPLE OF ANTENNA GROUNDING AS PER NATIONAL ELECTRICAL CODE

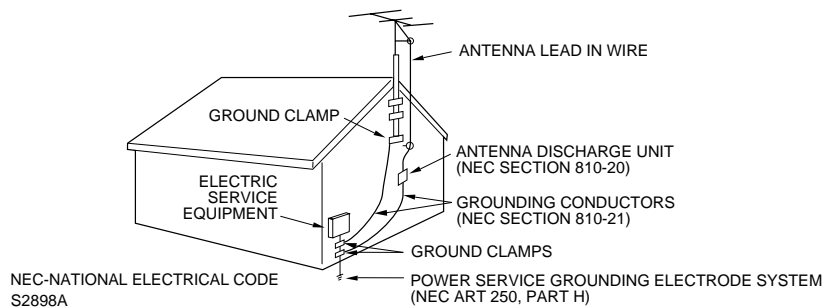



## FEATURES

- **181 Channel Tuner** - The tuning system is capable of receiving all 68 VHF/UHF standard broadcast channels that are available in your area. When operating on a cable system, it can tune to the standard VHF channel frequencies plus up to 113 cable channel frequencies. The actual number of channels received depends upon channel reception in your area or your cable system.
- **On-Screen 3 Language Display** - This TV can display the on screen language in English, Spanish or French.
- **Sleep Timer** - Operable from the remote control, this TV can be programmed up to 120 minutes to turn off automatically.
- **Memory Back Up** - This system prevents loss of memorized channel selections in case a power interruption to the TV should occur.
- **V-Chip** - The V-Chip function can read the rating of a TV program or movie content if the program is encoded with this information. V-Chip will allow you to set a restriction level.
- **Picture Control Adjustments** - The On-Screen display allows precise remote control adjustment of BRIGHTNESS, COLOR, CONTRAST, SHARPNESS and TINT.
- **Closed Captioned Decoder** - Displays text captions or 1/2 of full screen text on the screen for hearing impaired viewers.
- **Stereo/SAP Reception** - This TV is designed to receive stereo and separate audio program (SAP) broadcasts where available.

## LOCATION OF CONTROLS

FRONT

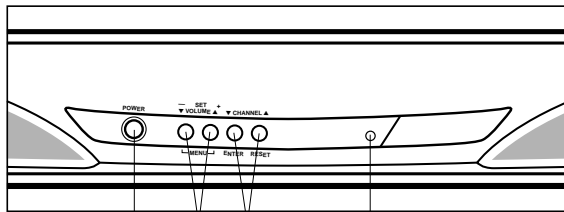
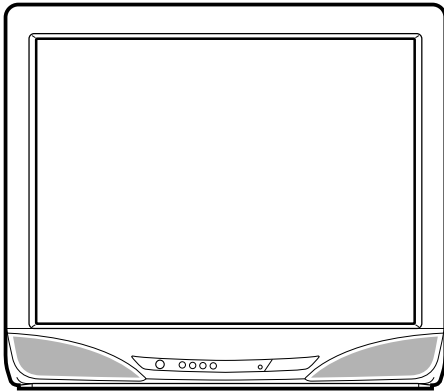

1. **POWER Button** - Press to turn the TV on or off.
2. **VOLUME ▼ / ▲ Buttons** - Press to raise or lower the level of the sound.  
**(MENU Buttons)** - Press both buttons to display the On-Screen menu functions.  
**(SET - / + Buttons)** - Press to select the desired setting during On-Screen operations.
3. **CHANNEL ▼ / ▲ Buttons** - Press to select a higher or lower numbered channel set into memory.  
**(ENTER Button)** - Press to enter or select information for On-Screen operations.  
**(RESET Button)** - Press to reset the On-Screen picture and sound adjustments to their factory preset positions. Press to reset a password in the V-CHIP Password setting mode.

4

BACK

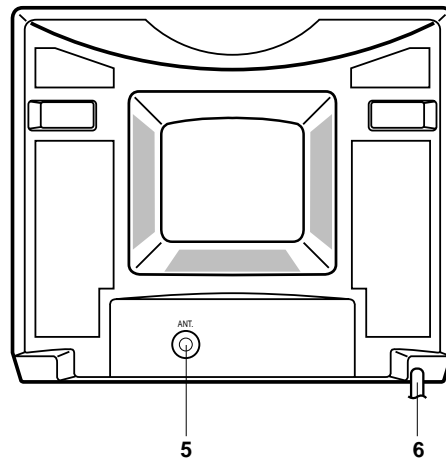

4. **Remote Sensor** - Signals from the Remote Control unit are received here.
5. **VHF/UHF IN (ANT) Jack** - Connect a VHF/UHF antenna or CATV cable to this jack.
6. **AC Power Cord** - Plug into an outlet having 120V, 60 Hz AC power only.





# REMOTE CONTROL

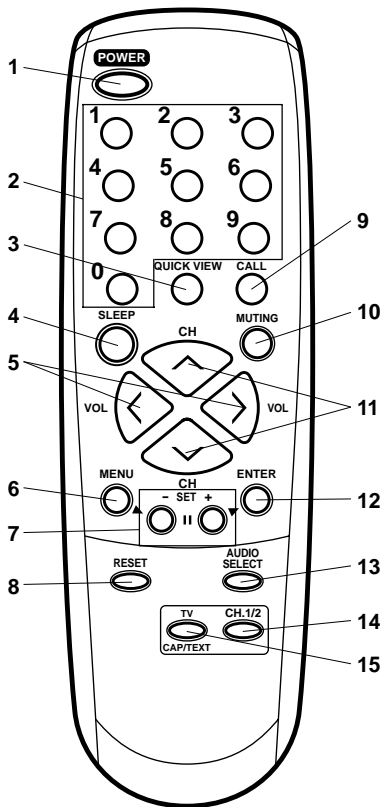

1. **POWER Button** - Press to turn the TV on. Press again to turn the TV off.
2. **Direct Channel Selection Buttons (0-9)** - Allows direct access to any channel.
3. **QUICK VIEW Button** - This button allows you to go back to the previous channel selected by just pressing the QUICK VIEW button. Press this button again to return to the channel you were watching.

4. **SLEEP Button** - To set the TV to turn off after a preset amount of time, press the SLEEP button on the remote control. The clock will count down 10 minutes each time the button is pressed in the order of 120, 110, 100, ..... 20, 10, 0. After the sleep time is programmed, the display will disappear then reappear momentarily every ten minutes to remind you the sleep timer function is operating. To confirm the sleep time setting, press the SLEEP button once and the remaining time will be momentarily displayed. To cancel sleep time, press the SLEEP button repeatedly until the display turns to 0.
5. **VOL (VOLUME) >/< Buttons** - Press the > button to increase, or the < button to decrease the volume level.
6. **MENU Button** - Press to display the On-Screen menu function.
7. **SET - / + Buttons** - Press to select the desired setting during On-Screen operations.
8. **RESET Button** - Press to reset the On-Screen picture and sound adjustments to their factory preset positions.
9. **CALL Button** - When you press this button, the channel number will appear in the upper right corner of the screen. Press the button again to remove display from the screen.
10. **MUTING Button** - To turn off the sound, press this button once. The TV will be silenced and the symbol "MUTING" will appear on the screen. The muting feature can be released by pressing the MUTING button again or one of the VOL > or < buttons.
11. **CH (CHANNEL) ^ / v Buttons** - Press the ^ button to change to a higher numbered channel set into memory. Press the v button to change to a lower numbered channel set into memory.
12. **ENTER Button** - Press to enter or select information for On-Screen operations.
13. **AUDIO SELECT Button** - Switches sound between mono, stereo, and SAP when receiving broadcasts in stereo or SAP.
14. **CH.1/2 Button** - Switches between Channel 1 and Channel 2 in the Closed Caption mode.
15. **TV/CAP/TEXT Button** - Press this button to switch between normal TV and the two Closed Caption modes (captions and 1/2 of full screen text). Closed Captioning will display text on screen for hearing impaired viewers.

ENGLISH

Before using the remote control, batteries must first be installed.

## HOW TO INSTALL BATTERIES

1. Open the battery compartment cover.

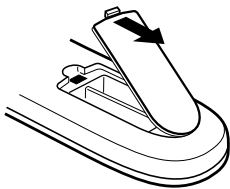

2. Install two "AAA" batteries.

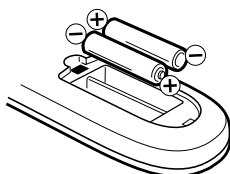

3. Replace the battery compartment cover.

Use two "AAA" size batteries. The batteries may last approximately one year depending on how much the remote control is used. For best performance, it is recommended that batteries should be replaced on a yearly basis, or when the remote operation becomes erratic. Do not mix old and new batteries or different types.

## BATTERY PRECAUTIONS

These precautions should be followed when using batteries in this device:

- Use only the size and type of batteries specified.
- Be sure to follow the correct polarity when installing the batteries as indicated in the battery compartment. Reversed batteries may cause damage to the device.
- Do not mix different types of batteries together (e.g. Alkaline and Carbon-zinc) or old batteries with fresh ones.
- If the device is not to be used for a long period of time, remove the batteries to prevent damage or injury from possible battery leakage.
- Do not try to recharge batteries not intended to be recharged; they can overheat and rupture (Follow battery manufacturer's directions).





# ANTENNA/CATV CONNECTIONS

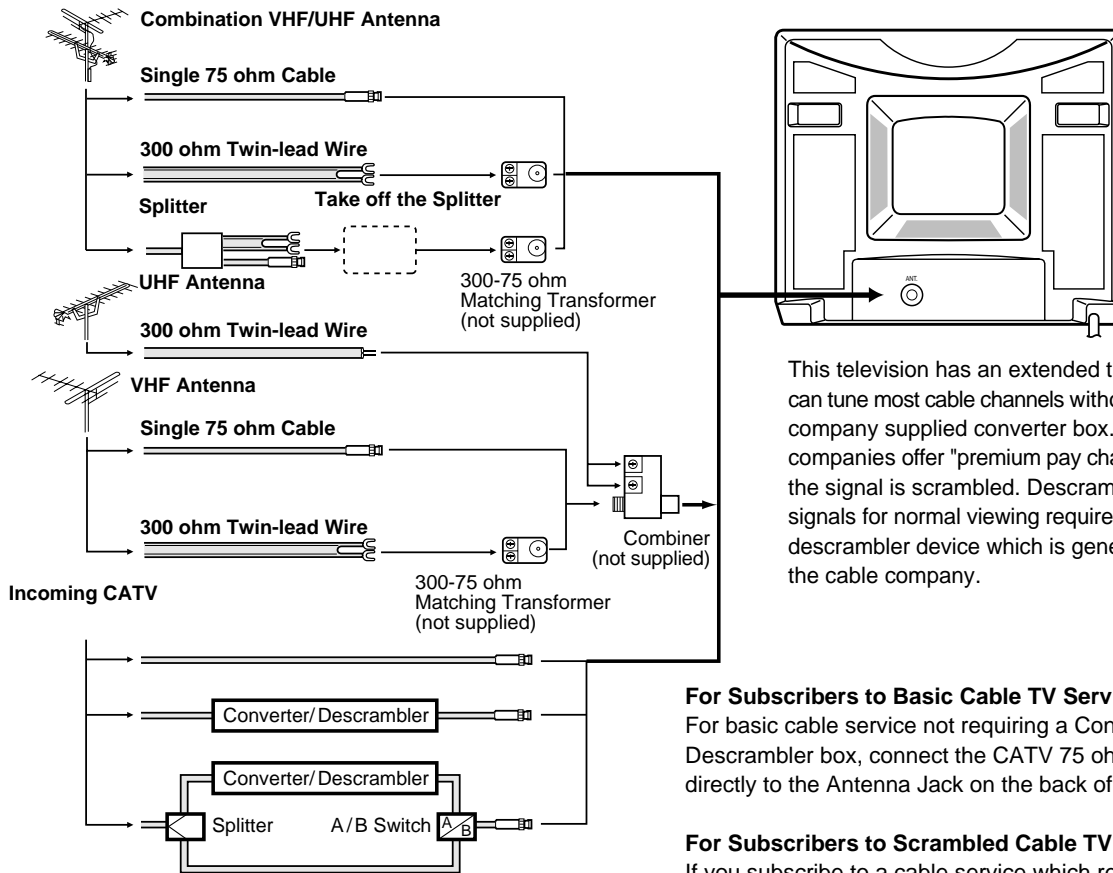

This television has an extended tuning range and can tune most cable channels without using a cable company supplied converter box. Some cable companies offer "premium pay channels" in which the signal is scrambled. Descrambling these signals for normal viewing requires the use of a descrambler device which is generally provided by the cable company.

### For Subscribers to Basic Cable TV Service

For basic cable service not requiring a Converter/Descrambler box, connect the CATV 75 ohm Coaxial Cable directly to the Antenna Jack on the back of the television.

### For Subscribers to Scrambled Cable TV Service

If you subscribe to a cable service which requires the use of a Converter/Descrambler box, connect the incoming cable to the Converter/Descrambler box and connect the output of the box to the Antenna Jack on the back of the television. Follow the connections shown left. Set the television to the output of the Converter/Descrambler box (usually channel 3 or 4) and use the Converter/Descrambler box to select channels.

### For Subscribers to Unscrambled Basic Cable with Scrambled Premium Channels

If you subscribe to a cable service in which basic cable channels are unscrambled and premium channels require the use of a Converter/Descrambler box, you may wish to use a two-set signal splitter (sometimes called a "two-set coupler") and an A/B Switch box from the cable installer or an electronics supply store. Follow the connections shown left. With the switch in the "B" position, you can directly tune any unscrambled channels on your TV. With the switch in the "A" position, tune your TV to the output of the Converter/Descrambler box (usually channel 3 or 4) and use the box to tune scrambled channels.

### Combination VHF/UHF Antenna (Single 75 ohm Cable or 300 ohm Twin-lead Wire)

Connect the 75 ohm cable from a combination VHF/UHF antenna to the Antenna Jack. If your combination antenna has a 300 ohm Twin-lead Wire, use the 300-75 ohm Matching Transformer (not supplied).

### Combination VHF/UHF Antenna (Separate VHF and UHF 300 ohm Twin-leads)

Connect the UHF Twin-lead Wire to a Combiner (not supplied). Connect the VHF Twin-lead to the 300-75 ohm Matching Transformer (not supplied). Attach the Transformer to the Combiner. Attach the Combiner to the Antenna Jack.

### Separate VHF/UHF Antennas

Connect the 75 ohm Cable from the VHF antenna and the UHF antenna Twin-lead to a combiner (not supplied). Attach the Combiner to the Antenna Jack.

**NOTE:** If your VHF antenna has a Twin-lead Wire, use the 300-75 ohm Matching Transformer (not supplied), then connect the Transformer to the Combiner.





# SETTING LANGUAGE

This TV can display the on-screen language in English, Spanish or French. On-screen language selection (step 3) will automatically appear on the screen when you press the MENU button initially. Select the language you prefer first, then proceed with the other menu options.

1 Press the MENU button.

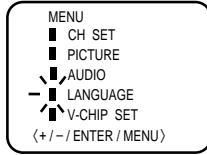

2 Press the SET + or - button to select the LANGUAGE mode, then press the ENTER button.

3 Press the SET + or - button to select the desired language: English (ENGLISH), Spanish (ESPAÑOL) or French (FRANCAIS), then press the ENTER button.

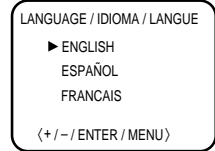

4 Press the MENU button until the menu screen is cleared.

ENGLISH

### NOTE:

If Spanish or French is chosen, the Closed Caption indicators will be in the selected language, but the Closed Caption text will not be affected by the language selection.

# TV OPERATION

1 To turn on the TV, press the POWER button.

2 The VOLUME can be adjusted to a desired level by pressing the VOL (VOLUME) > or < button.

The sound level will be indicated on the TV screen by green bars and a number. As the sound level increases, so do the number of bars and the number on the screen. The same is true for decreasing the level.

3 Set the TV/CATV menu option to the desired position. When shipped from the factory, this menu setting is in the CATV setting. See "TO MEMORIZE CHANNELS".

TV	- VHF/UHF channels
CATV	- CABLE TV channels

4 **CH (CHANNEL) Up and Down buttons**  
Press and release the CH (CHANNEL) ^ or v button. The channel automatically stops at the next channel set into memory. Press and hold the button down to change channels more quickly.

For proper operation, before selecting channels, they should be set into the TV's memory. See "TO MEMORIZE CHANNELS".

### Direct Channel Selection buttons (0-9)

Press these buttons to select a channel. The channel number will appear on the upper right corner of the TV screen. If an invalid channel number is selected, the display will revert to the original channel.

### TV Mode Direct Channel Selection

When the TV/CATV menu option is in the TV setting, all channels can be instantly selected by using two buttons. (For example, to select channel 2, press "0", then "2". If you press only "2", channel selection will be delayed for a few seconds). For channels 10 and above, press the 2 digits in order.

### CATV Mode Direct Channel Selection

When the TV/CATV menu option is in the CATV setting, channels can be selected as follows:

CH. 1-9	Press "0" twice, then 1-9 as needed. Example, to select channel 2, press "002".
CH. 10-12	Press "0", then remaining 2 digits. Example, to select channel 12, press "012".
CH. 13-99	Press the 2 digits in order. Example, to select channel 36, press "36".
CH. 100-125	Press the 3 digits in order. Example, to select channel 120, press "120".

**NOTE:** If the station being viewed stops broadcasting, the TV will automatically shut off after 15 minutes.

### SLEEP

To set the TV to turn off after a preset amount of time, press the SLEEP button on the remote control. The clock will count down 10 minutes each time the button is pressed in the order of 120, 110, 100, ..... 20, 10, 0. After the sleep time is programmed, the display will disappear then reappear momentarily every ten minutes to remind you the sleep timer function is operating. To confirm the sleep time setting, press the SLEEP button once and the remaining time will be momentarily displayed. To cancel sleep time, press the SLEEP button repeatedly until the display turns to 0.

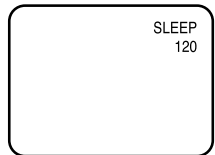





# TO MEMORIZE CHANNELS

This TV is equipped with a channel memory feature which allows channels to skip up or down to the next channel set into memory, skipping over unwanted channels. Before selecting channels, they must be programmed into the TV's memory. In addition to normal VHF and UHF channels, this TV can receive up to 113 Cable TV channels. To use this TV with an antenna, set the TV/CATV menu option to the TV setting. When shipped from the factory, this menu option is in the CATV setting.

## TV/CATV SELECTION

- 1 Press the MENU button.
- 2 Press the SET + or – button until the indicator next to "CH SET" begins to flash, then press the ENTER button.
- 3 Press the SET + or – button until the indicator next to "TV/CATV" begins to flash.
- 4 Press the ENTER button to select the TV or CATV mode. The arrow indicates the selected mode.
- 5 Press the MENU button twice to return to normal TV viewing.

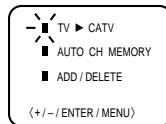
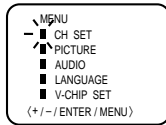

The chart below is typical of many cable system channel allocations.

## CATV CHART

Number on this TV	14	15	16	17	18	19	20	21	22
Corresponding CATV channel	A	B	C	D	E	F	G	H	I
23	24	25	26	27	28	29	30	31	32
J	K	L	M	N	O	P	Q	R	S
41	42	43	44	45	46	47	48	49	50
EE	FF	GG	HH	II	JJ	KK	LL	MM	NN
59	60	61	62	63	64	65	66	67	68
WW	AA	BB	CC	DD	EE	FF	GG	HH	II
77	78	79	80	81	82	83	84	85	86
RRR	SSS	TTT	UUU	VVV	WWW	XXX	YYY	ZZZ	88
95	96	97	98	99	100	101	102	103	104
A-5	A-4	A-3	A-2	A-1	100	101	102	103	104
113	114	115	116	117	118	119	120	121	122
113	114	115	116	117	118	119	120	121	122

**NOTE:** Contact your cable company to determine the type of cable system used in your area.

## AUTOMATIC CHANNEL MEMORY

- 1 Press the MENU button.
- 2 Press the SET + or – button until the indicator next to "CH SET" begins to flash, then press the ENTER button.
- 3 Press the SET + or – button until the indicator next to "AUTO CH MEMORY" begins to flash, then press the ENTER button. The TV will begin memorizing all the channels available in your area. Channel numbers will remain red until auto memorizing is complete.

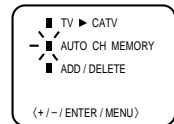
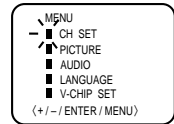

- 4 Press the MENU button twice to return to normal TV viewing.

## TO ADD/DELETE CHANNELS

- 1 Press the MENU button.
- 2 Press the SET + or – button until the indicator next to "CH SET" begins to flash, then press the ENTER button.
- 3 Press the SET + or – button until the indicator next to "ADD/DELETE" begins to flash, then press the ENTER button.

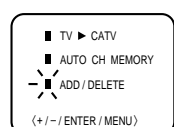
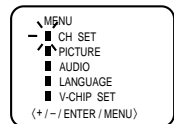

- 4 Select the desired channels to be added or deleted using the Direct Channel Selection buttons (10 keys, 0-9), the CH ^ or v button or the SET + or – button.
- 5 Press the ENTER button to select ADD or DELETE. If an unmemorized channel was selected (step 4), the channel indication will be red. Press the ENTER button if you wish to ADD the unmemorized channel. The channel indicator will change from red to green when a channel is added and the channel will be memorized. If a memorized channel was selected (step 4), the channel indication will be green.

Press the ENTER button if you wish to DELETE the channel from memory. The channel indicator will change from green to red when a channel is deleted.

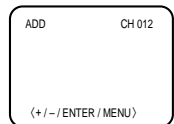

Repeat Steps 4 and 5 for each channel to be added or deleted.

- 6 Press the MENU button three times after adding or deleting all of the desired channels, to return to normal TV viewing.









## STEREO AND SEPARATE AUDIO PROGRAM (SAP)

The TV is equipped with a feature known as Multi-channel TV Sound or MTS. MTS broadcasts greatly enhance TV viewing by bringing you programs with high fidelity stereo sound. MTS also provides an extra channel called the Separate Audio Program or SAP which broadcasters can use to transmit a second language for bilingual transmission or for other purposes.

### LISTENING TO STEREO SOUND

When the TV is turned on or a channel selection is made, make certain that the word "STEREO" appears on the screen. This means that "Stereo" broadcasting is available. You can enjoy stereo sound from the left and right speakers.

- When the "Mono" broadcasting is received, no indication is displayed.
- If the broadcast signal is not strong enough or clear stereo sound is not available, press the AUDIO SELECT button to change to mono sound. The noise should be eliminated. Press it again to return to the stereo sound.

### LISTENING TO SAP (SEPARATE AUDIO PROGRAM)

When the TV is turned on or a channel selection is made, make certain that the letters "SAP" appear on the screen. This means that the "Separate Audio Program" broadcasting is available.

### TO SELECT DESIRED SOUND

Press the AUDIO SELECT button to select the desired sound.

### MONO+SAP BROADCASTING

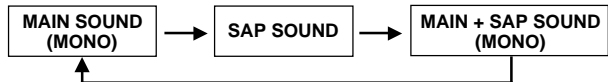

### STEREO+SAP BROADCASTING

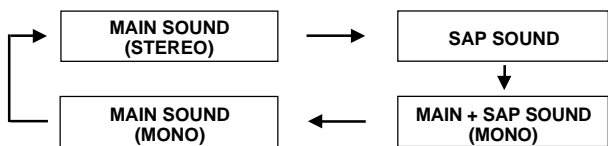

## SOUND ADJUSTMENTS

Sound controls are factory preset but you can adjust them individually as follows:

To display sound adjustments on the screen, press the MENU button. Press the SET + or – button to select the AUDIO option, then press the ENTER button.

### BASS

Press the ENTER button until "BASS" appears on the screen, then press the SET + or – button to adjust the bass sound.

### TREBLE

Press the ENTER button until "TREBLE" appears on the screen, then press the SET + or – button to adjust the treble sound.

### BALANCE

Press the ENTER button until "BALANCE" appears on the screen, then press the SET + or – button to obtain an equal sound level from both speakers.

### RESET

Pressing the RESET button while making sound adjustments will return all adjustments to the factory preset levels.

**NOTE:** The on-screen display will disappear 6 seconds after finishing an adjustment. The settings can only be adjusted when they are displayed on the TV screen.

## ADJUSTING PICTURE

You can adjust the settings for color, sharpness, contrast, brightness and tint.

- 1 Press the MENU button.
- 2 Press the SET + or – button until the indicator next to "PICTURE" begins to flash, then press the ENTER button.
- 3 Press the ENTER button repeatedly to select the item you want to adjust.

BRIGHTNESS → CONTRAST → COLOR → TINT → SHARPNESS

- 4 Press the SET + or – button to adjust the setting.

	+	–
<b>BRIGHTNESS</b>	increase brightness	decrease brightness
<b>CONTRAST</b>	increase contrast	decrease contrast
<b>COLOR</b>	be brilliant color	be pale color
<b>TINT</b>	be greenish color	be reddish color
<b>SHARPNESS</b>	makes picture clearer	makes picture softer

### TO RETURN TO INITIAL SETTING

Press the RESET button while the picture adjusting mode appears on-screen.



# TROUBLESHOOTING GUIDE

Before requesting service, please refer to the following chart for the symptom and possible solution.

SYMPTOMS	POSSIBLE SOLUTIONS
TV does not operate	<ul style="list-style-type: none"> <li>• Make sure the power cord is plugged in.</li> <li>• Try another AC outlet.</li> <li>• Power is off, check fuse or circuit breaker.</li> <li>• Unplug unit for an hour, then plug it back in.</li> </ul>
Poor sound or No sound	<ul style="list-style-type: none"> <li>• Station or CATV experiencing problems, tune to another station.</li> <li>• Check sound adjustments (Volume and Muting).</li> <li>• Check for sources of possible interference.</li> </ul>
Poor picture or No picture	<ul style="list-style-type: none"> <li>• Station or CATV experiencing problems, tune to another station.</li> <li>• Make sure channels are set into memory.</li> <li>• Check antenna or CATV connections, adjust antenna.</li> <li>• Check for sources of possible interference.</li> <li>• Check picture control adjustments.</li> </ul>
Poor reception on some channels	<ul style="list-style-type: none"> <li>• Station or CATV experiencing problems, tune to another station.</li> <li>• Make sure channels are set into memory.</li> <li>• Station is weak, adjust antenna to receive desired station.</li> <li>• Check for sources of possible interference.</li> </ul>
Poor color or no color	<ul style="list-style-type: none"> <li>• Station or CATV experiencing problems, tune to another station.</li> <li>• Make sure channels are set into memory.</li> <li>• Check picture control adjustments.</li> <li>• Check antenna or CATV connections, adjust antenna.</li> <li>• Check for sources of possible interference.</li> </ul>
Picture wobbles or drifts	<ul style="list-style-type: none"> <li>• Station or CATV experiencing problems, tune to another station.</li> <li>• Make sure channels are set into memory.</li> <li>• CATV company is scrambling signal.</li> <li>• Adjust antenna.</li> </ul>

SYMPTOMS	POSSIBLE SOLUTIONS
No CATV reception	<ul style="list-style-type: none"> <li>• Check all CATV connections.</li> <li>• Set TV/CATV menu option to the CATV mode.</li> <li>• Station or CATV system problems, try another station.</li> </ul>
Horizontal or diagonal bars on screen	<ul style="list-style-type: none"> <li>• Check antenna connections, adjust or re-direct antenna.</li> <li>• Check for sources of possible interference.</li> </ul>
No reception above channel 13	<ul style="list-style-type: none"> <li>• Make sure TV/CATV menu option is in the appropriate mode.</li> <li>• If using antenna, check UHF antenna connections.</li> </ul>
No Remote operation	<ul style="list-style-type: none"> <li>• Batteries are weak, dead or inserted incorrectly.</li> <li>• Remote is out of range, move closer to TV (within 15 feet).</li> <li>• Make sure Remote is aimed at sensor.</li> <li>• Confirm there are no obstructions between the Remote and the TV.</li> <li>• Make sure the power cord is plugged in.</li> </ul>
TV shuts off	<ul style="list-style-type: none"> <li>• No broadcast on station tuned.</li> <li>• Sleep Timer is set.</li> <li>• Power interrupted.</li> </ul>
No reception	<ul style="list-style-type: none"> <li>• Reset your password.</li> </ul>
Closed - Caption is not activated	<ul style="list-style-type: none"> <li>• TV station experiencing problems or program tuned is not closed captioned. Try another channel.</li> <li>• Check CATV connection or VHF/UHF antenna, reposition or rotate antenna.</li> <li>• Press TV/CAP/TEXT button to turn on the closed caption decoder.</li> </ul>
Display is not shown in your language	<ul style="list-style-type: none"> <li>• Select proper language in the menu options.</li> </ul>

ENGLISH

## SPECIFICATIONS

AC Power Input: 120V, 60Hz  
 AC Power Consumption: 110 Watts  
 Chassis Construction: IC Solid state  
 Picture Tube: 25" (measured diagonally)  
 Horizontal resolution: 260 lines  
 Audio Power Output Rating: 2.5 + 2.5 Watts  
 Speaker: 1-1/2" x 2-11/16" Full Range, 8 ohm x 2  
 Tuner Type: 181 Channel, Quartz PLL Frequency Synthesized  
 Remote Control: Infrared, Direct Access, 2 x AAA batteries (not supplied)

Receiving Channels:  
 VHF 2-13  
 UHF 14-69  
 CATV 01-97 (5A)-(A-3)  
 98-99 (A-2)-(A-1)  
 14-22 (A)-(I)  
 23-36 (J)-(W)  
 37-65 (AA)-(FFF)  
 66-125 (GGG)-(125)  
 Antenna Input Impedance: 75 Ohm (VHF/UHF/CATV) Coaxial Input  
 Dimensions: 24-5/16" (W) x 19-13/16" (D) x 20-11/16" (H)  
 Weight: 59.9 lbs

## ACCESSORY

Remote Control



For additional set-up or operating assistance, please visit our WEBSITE at [www.memcorpinc.com](http://www.memcorpinc.com) or contact CUSTOMER SERVICE at 1-800-919-3647

Please keep all packaging material for at least 90 days in case you need to return this product to your place of purchase or Memorex.

FOR PARTS AND ACCESSORIES, CONTACT FOX INT'L AT 1-800-321-6993"



